

# BL-IS – Module Irrigation Secteur

## GUIDE D'INSTALLATION RAPIDE



FR	P01
EN	P11
ES	P22
IT	P33



[customersupport@solem.fr](mailto:customersupport@solem.fr)

+33 467 592 425

[www.solem.fr](http://www.solem.fr)

## INTRODUCTION

Les produits BL communiquent avec l'application SolemWF sur smartphone ou tablette en utilisant la technologie Bluetooth SMART 4.0 (Low Energy) présente sur la plupart des nouveaux téléphones (iPhone 4S et supérieur SAMSUNG S3 et supérieur, etc...)

Assurez-vous que votre appareil soit par conséquent compatible avec cette technologie Bluetooth 4.0.

Les produits BL permettent de piloter l'arrosage, l'éclairage de jardin ainsi que des pompes de fontaine ou tout autre produit pilotable grâce à un relai à contact sec. Les programmes d'arrosage ou d'automatisme sont transmis dans les modules BL à partir de l'application SolemWF disponible gratuitement sur l'App Store ou Google Play (Play Store).

L'utilisateur doit d'abord associer son produit BL à son smartphone ou sa tablette.

# 1- TELECHARGEZ L'APPLICATION SolemWF

Vérifiez que votre appareil est bien connecté à internet (Wi-Fi ou 3G minimum)

Téléchargez l'application SolemWF



Depuis les plateformes de téléchargement Apple ou Android.



## 2- ASSOCIATION

1 - A la mise sous tension, le module BL-IS démarre en mode association durant 2 minutes.

2 - Activez le Bluetooth sur votre smartphone en allant dans les réglages.



3 - Lancez l'application

SolemWF



Au 1<sup>er</sup> démarrage de l'application, la page suivante apparaît.

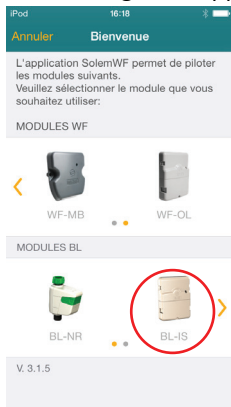

4 -Faites glissez votre doigt sur les produits vers la gauche sur l'image des produits pour voir les autres modules, puis appuyer sur l'image qui correspond au **module BL-IS** que vous souhaitez associer.

Le produit apparait en orange dans la liste des modules détectés par l'application.

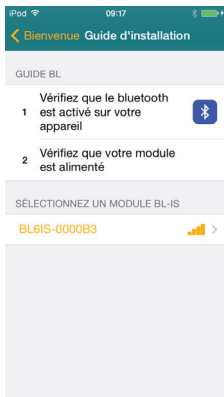

5 - Appuyer sur le N° du produit. Ce Numéro correspond au "Default Name" présent sur l'étiquette à l'arrière du produit.

**Important :**

*Vous pouvez changer le nom du module ou ajouter une clé de sécurité pour éviter que tout autre personne à portée radio de votre produit Bluetooth se connecte et change les données.*

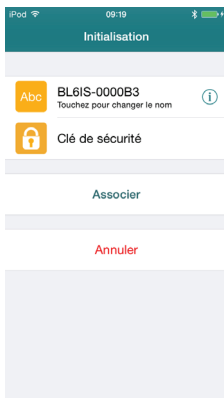

6 - Pour changer le nom du module, appuyer sur le N° (comme vu sur p4)



Modifier le nom, puis appuyez sur "Changer".

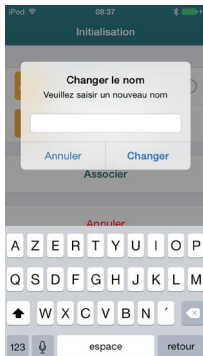

7 - Pour changer la clé, appuyer sur "Clé de Sécurité" (comme vu sur p4)



Ajouter un code à 7 chiffres maximum. Appuyer ensuite sur "Changer".



8 - Appuyez sur "Associer" pour terminer l'association. Votre produit apparaît dans la liste des modules associés.

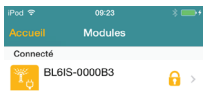

← Si vous avez ajouté une clé, un cadenas apparaît en face du nom du module

## **IMPORTANT:**

*Si vous devez ajouter d'autres modules ou réassocier un produit, il faut maintenant aller sur la page d'accueil et appuyer sur "Ajouter un module".*

*Reprenez les instructions d'associations du point N°1, vérifier bien le N° du produit sur l'étiquette à l'arrière du produit avant de cliquer dessus pour l'associer*

## **CAS D'OUBLI DE LA CLE DE SECURITE**

En cas d'oubli de la clé de sécurité, vous devez débrancher et rebrancher l'alimentation du produit afin qu'il redémarre dans sa phase d'initialisation.

Appuyer ensuite sur "Ajouter un module" sur l'écran d'accueil et suivez les instructions ci-dessus pour réaffecter une clé

## **3- PROGRAMMATION**

La programmation d'arrosage étant intuitive et simple, vous pouvez dès à présent créer vos programmes d'arrosage. Si vous rencontrez des difficultés, connectez vous au site Solem pour vous informer ou envoyez vos questions à :

***customersupport@solem.fr***

## 4- FIXATION ET CABLAGE DU MODULE

Fixez le produit BL en intérieur uniquement à l'aide des 3 vis fournies

- Installez votre produit de telle sorte que le socle de prise de courant soit à proximité du matériel. La prise de courant est un dispositif de sectionnement, en cas de problème, elle doit être aisément accessible à tout moment.

- Assurez-vous que la prise de courant sur laquelle votre transformateur d'alimentation est branché présente une protection contre les surintensités et les court circuits de type disjoncteur 16A (20A pour les US).

Utiliser uniquement le bloc alimentation fourni avec le produit 24Vac 0.75A

Température ambiante maximale d'utilisation du produit : 45°C

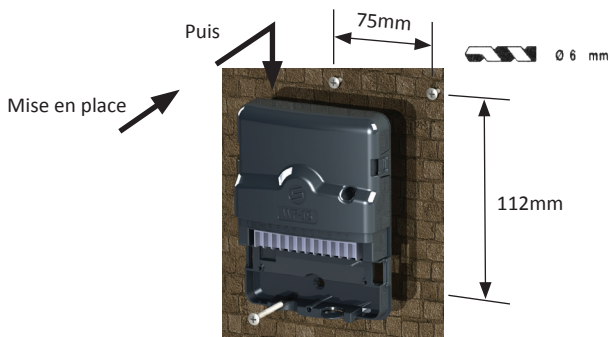

Utilisez des électrovannes avec Solénoïdes 24Vac

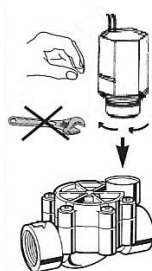
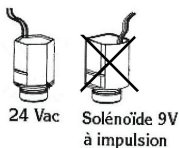



# CÂBLAGE DES FILS SOLENOÏDES

Alimentation  
24VAC, 0.75A

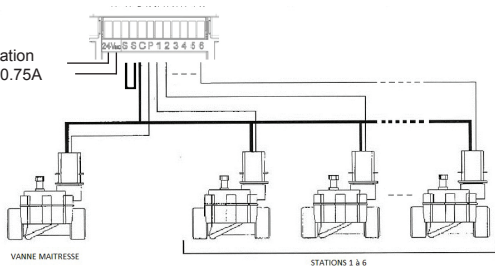

## OPTION : CÂBLAGE D'UNE SONDE DE PLUIE

Retirez le strap jaune et mettez la sonde à contact sec de type RSD-BEx ou équivalent à la place

Alimentation  
24VAC, 0.75A

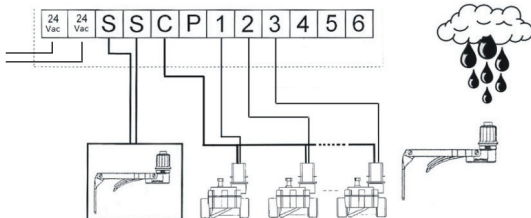

## 5- INFORMATIONS COMPLEMENTAIRES

### Configuration Requite

iOS 7 Minimum : iPhone 4S et supérieur, iPad 3 et supérieur, iPod Touch 5.  
Android 4.3 Minimum : Samsung S3 et supérieur / Note 2 / Google Nexus 7  
2013 / Sony Xperia Z, Z1  
Tout appareil comportant un niveau de Bluetooth Smart 4.0.

### Résolution de problèmes

Pas de communication ou aucun module détecté

Vérifier que vous avez bien activé le Bluetooth du téléphone et vérifier que vous avez activé la recherche des produits BL.

Pas d'irrigation

Vérifier l'alimentation  
Vérifier le cablage de la sonde de pluie  
Vérifier le cablage des stations et les courts circuits

Décalage des programmes

Le module a perdu l'heure suite a une coupure secteur, resynchroniser avec l'application

### Signification de la LED sur la face avant du module

Etat de la Led	Signification
Rouge fixe pendant 2mn	Mode installation, module en attente de configuration initiale à la première installation.
2 x Flash rouge	Suite coupure secteur, le module a perdu l'heure
4 x Flash rouge	Défaut sur une voie => court circuit
Vert fixe Vert Clignotant	Mode marche Irrigation en cours
Alternance rouge/vert	1 Station est en cours mais l'arrosage est suspendu par une sonde de pluie ou un OFF
Eteinte	Pas d'alimentation

## 6- DECLARATION CONFORMITE

Solem Electronique déclare que le Module Irrigation Secteur de type BL-IS est conforme aux exigences essentielles de la directive R&TTE 1999/5/CE.

Ce produit respecte les normes harmonisées suivantes :

Norme RADIO : ETSI EN 300 328 v1.8.1

Norme EMF : EN 62311 (2008) et la recommandation 1999/519/CE

Norme CEM : ETSI EN 301 489-1 v.1.9.2 et ETSI EN 301 489-17 v2.2.1

Norme Sécurité Electrique : EN 60950-1 éd. 2006 + A1 éd. 2010 +A11 de 2009 + A12 de 2011 et IEC 60950-1 éd. 2

Clapiers le 22/10/13

Directeur Général  
SOLEM ELECTRONIQUE  
ZAE La Plaine  
5, rue Georges Besse  
34830 Clapiers

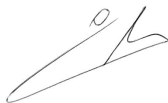
A handwritten signature in black ink, consisting of a stylized, cursive script that is difficult to decipher but appears to be a personal name.

# BL-IS – Irrigation Module Sector

## QUICK INSTALLATION GUIDE



FR P01

EN P11

ES P22

IT P33



[customersupport@solem.fr](mailto:customersupport@solem.fr)

+33 467 592 425

[www.solem.fr](http://www.solem.fr)

## INTRODUCTION

The BL products communicate with the SolemWF application on a smartphone or a tablet by using the Bluetooth SMART 4.0 technology (Low Energy) on the newest phones (iPhone 4S and later, SAMSUNG GALAXY S3 and later etc...).

Make sure that your system is compatible with the Bluetooth 4.0 technology.

The BL products allow to pilot the garden irrigation, lighting and also fountain pumps or any other product which can be managed thanks to a dry contact relay. The watering or automation programs are transmitted to the BL modules from the free SolemWF application which can be downloaded on the App Store or Google Play (Play Store).

The user has to associate its BL product to its smartphone or tablet.

# 1- DOWNLOAD THE SolemWF APPLICATION

Make sure your device is connected to the internet (Wi-Fi or 3G minimum)

Download the SolemWF application



From the App Store

or

Google Play



## 2- ASSOCIATION

1 - When turned on, the BL-IS module starts in an association mode for 2 minutes.

2 - Activate for Bluetooth in your smartphone's settings



3 - Open the SolemWF application



This following page will show up at the first launch of the application

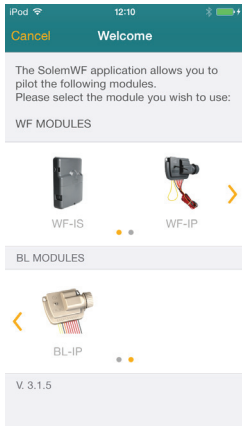
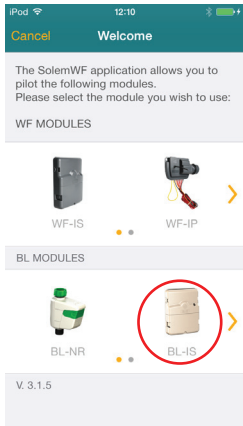

4 - Slide your finger to the left on the image of BL products to show the other modules, then press on the picture which corresponds to the BL module you want to associate

The product appears in orange characters among the list of modules detected by the App.

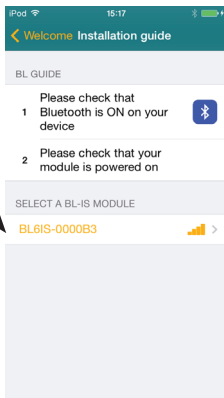

5 - Press on the product N°. This number matches with the « Default Name » on the label at the back side of the product.

**Important :**

*You can change the name of the product or add a security key in order to avoid that any person being able to access by radio frequency, could connect to your Bluetooth product system and change your data.*

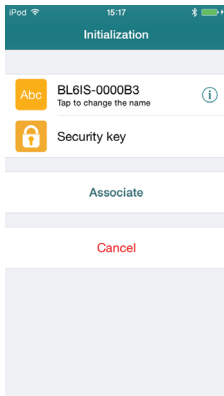



6 - To change the name of the module, you can tap on the current name (seen P15)



Enter a name then press "Change".

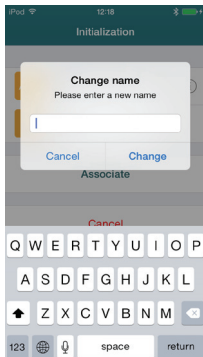

7 - If you need to change the key, press «Security Key » (seen P15)



Add a digit code up to 7 digits  
Then press "Change"

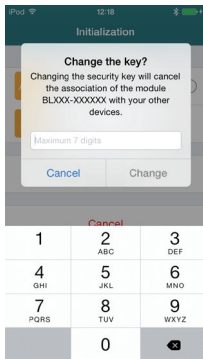

8 - Press on «Associate » to finish the association.  
Your product shows up in the list of associated modules

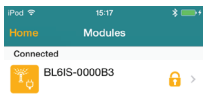

← *If you have added a security key, a padlock will appear on the screen of the list of modules*

### **IMPORTANT NOTICE:**

*If you need to add some other modules or associate a product again, go to the home page and tap « Add a module ».*

*Resume from the point one of association instructions, check out the Product ID on the label on the back of the product before tapping on it to associate.*

### **IF YOU FORGET THE SECURITY KEY**

If you forget the security key, you must de-plug and re-plug the power supply in order to restart the product in initialization mode (Reset).

Then press “Add a Module” on the home screen and follow the instructions above to reassign a key.

## **3- PROGRAMMATION**

The watering program is intuitive and simple. You can create your watering schedules. If you encounter problems, contact Solem to answer your questions at :

***customersupport@solem.fr***

## 4- MOUNTING AND WIRING MODULE

The BL case must be installed indoor use only. It can be fixed against a wall with the screws supplied with the product.

- The BL case must be installed the nearest possible of the electric plug. The power plug must be accessible at all time in order to unplug the device in case of emergency.

- Make sure that the power plug on which the transformer is plugged in has a overcurrent and short-circuit protection breaker for 16A (20A for US).

Use only power supply provided with product 24Vac 0.75A

Max operating temperature : 45°C

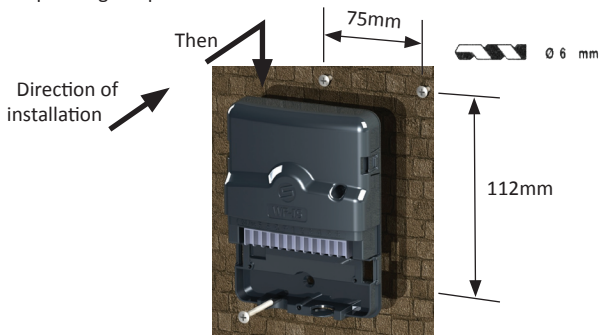

Use Solenoid valves with 24Vac

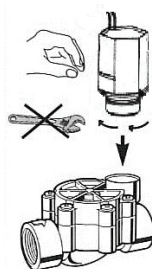
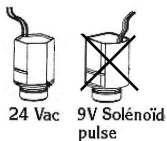

# WIRING SOLENOID

Power Supply  
24VAC,0.75A

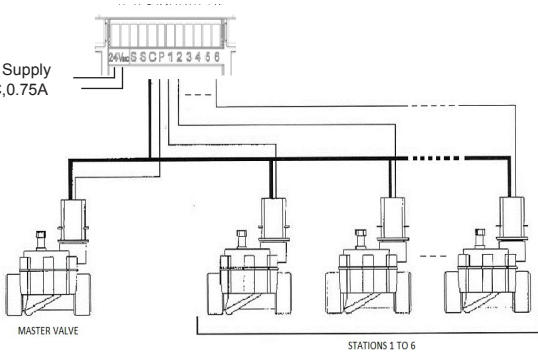

## OPTION : WIRING A RAIN PROBE

Remove the yellow strap and put the probe dry (type RSD-BEx or equivalent) contact instead

Power Supply  
24VAC,0.75A

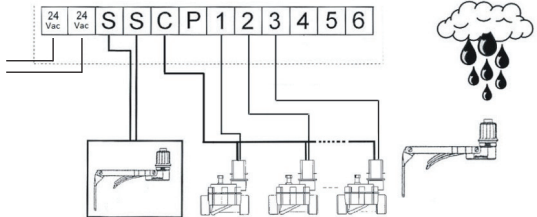

## 5- COMPLEMENTARY INFORMATION

### Required Configuration

iOS 7 Minimum : iPhone 4S and later, iPad 3 and later, iPod Touch 5. Android 4.3 Minimum : Samsung GALAXY S3 and later versions / Note 2 / Google Nexus 7 2013 / Sony Xperia Z, Z1  
Any device compatible with Bluetooth 4.0 (Smart).

### To solve problems

No communication or any module detected neither	Check that the phone bluetooth has been turned on and also that the scan research of the BL products is activated.
No irrigation	Verify power supply Verify sensor wiring Verify Stations wiring and no short circuit
Schedule Shifted	Controller had lost time after a long period of power failure and need to be resynchronize with the app.

### The meaning of the LED

LED Status	Meaning
Red fixed during 2mn	Installation mode : Controller is waiting initial configuration.
2 x red flashing	Following a power failure, the module lost time.
4 x red flashing	Failure on one channel => short circuit
Green Fixed Green flashing	Run Mode Irrigation in progress
Alternating red/green	Irrigation in progress but watering is suspended by rain sensor or an OFF
Off	No power supply

## 6- DECLARATION OF CONFORMITY

Solem Electronics said that the Irrigation Module Sector type BL-IS complies with the essential requirements of the R & TTE Directive 1999/5/EC

This product meets the following standards:

Radio Standard : ETSI EN 300 328 v1.8.1

EMF Standard : EN 62311 (2008) and recommendation 1999/519/CE

CEM Standard : ETSI EN 301 489-1 v.1.9.2 and ETSI EN 301 489-17 v2.2.1

Electrical Security Standard : EN 60950-1 éd. 2006 + A1 éd. 2010 + A11 de 2009 + A12 de 2011 and IEC 60950-1 éd. 2

Clapiers, 10/22/13

Managing Director SOLEM ELECTRONIQUE ZAE La Plaine

5, rue Georges Besse

34830 Clapiers

FRANCE

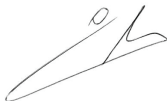
A handwritten signature in black ink, consisting of a stylized, cursive script that is difficult to decipher but appears to be a personal name.

# BL-IS – Módulo de Riego Sector

## GUÍA RÁPIDA DE INSTALACIÓN



FR	P01
EN	P11
<b>ES</b>	<b>P22</b>
IT	P33



customersupport@solem.fr  
+33 467 592 425  
www.solem.fr

## INTRODUCCION

Los productos BL comunican con la aplicación SolemWF en el smartphone o tableta usando la tecnología Bluetooth SMART4.0 (Baja energía) presente en la mayoría de los teléfonos (iPhone 4S y superior SAMSUNG S3 y superior,...).

Asegúrese de que vuestro aparato sea compatible con la tecnología Bluetooth 4.0

Los productos BL permiten de dirigir el riego, la luz del jardín así como las bombas de fuente o cualquier otro producto que puede ser pilotado gracias al relé de contacto seco. Las programas de riego o de automatismo son transmitidos a través de los módulos BL a partir de la aplicación SolemWF disponible gratuitamente en el App Store Google Play (Play Store).

El usador debe de asociar su producto BL con un smartphone o su tableta.



# 1- DESCARGAR APLICACIÓN SolemWF

Asegúrese de que su dispositivo esté conectado a Internet (Wi-Fi o 3G mínimo)

Descargar la aplicación SolemWF



desde las plataformas de descarga Apple ou Android.



## 2- ASOCIACION

1 - Cuando está funcionando, el módulo BL-IS se inicia en modo asociación

2 - Activar el Bluetooth con vuestro Smartphone, ir hasta en las configuraciones.



3 - Abrir la aplicación

SolemWF



En el primero inicio de la aplicación, la página siguiente aparece,

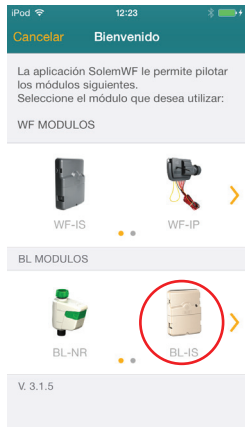

4 - Deslice vuestro dedo partiendo de la izquierda en la imagen de los productos BL para que los otros módulos pueden estar apareciendo. Presionar en la imagen que corresponde con el módulo BL que se desea asociar.

El producto aparece en naranja en la lista de módulos detectados por la aplicación

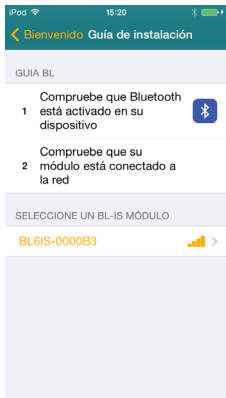

5 - Presionar en el N° del producto, correspondiente al “El nombre por defecto” que está en la etiqueta en la parte posterior del producto.

**Important :**

*Se puede simplemente cambiar la denominación del producto o adicionar una clave de seguridad para que ninguna persona se puede conectarse y cambiar vuestros datos.*

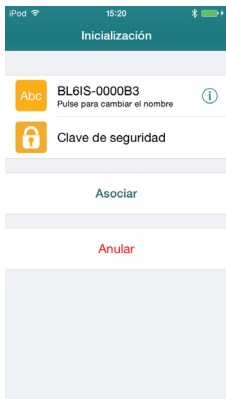

6 - Para cambiar el nombre del módulo, presione en el N° (visto en P26),



Modificar el nombre después presione el botón "Cambiar".

7 - Para cambiar la clave, pulsar « Clave de Seguridad » (visto en P26)



Y adicionar un código de 7 cifras máximo. Después presionar en "Cambiar"

8 - Presionar en "Asociar"  
Vuestro producto está apareciendo en la lista de módulos asociados

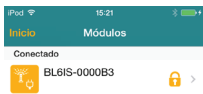

← Si se ha juntado una clave, un candado aparece en la frente del nombre del producto

### **NOTICIA IMPORTANTE:**

*En caso se necesita adicionar otros módulos o asociar de nuevo un producto, ahora tiene que ir hasta la página inicial y presionar en “Adicionar un módulo”.*

*Reanudar desde las instrucciones de asociación punto N°1, verificar el N° del producto con la etiqueta atrás del producto antes de presionar para asociarlo.*

### **OLVIDO DE LA CLAVE DE SEGURIDAD**

En caso se ha olvidado la clave de seguridad, se debe de desconectar y conectar de nuevo la alimentación del producto así se puede hacerlo funcionar en modo inicialización.

Presionar en “adicionar un módulo” en la pantalla principal y después seguir las instrucciones para reasignar la clave.

## **3- PROGRAMACIÓN**

La programación del sistema de riego es intuitiva y simple, con estos elementos nombrados ya puede crear sus propios programas. Si encuentra alguna dificultad o duda, conectarse al web de Solem y enviar sus preguntas a la dirección siguiente: ***customersupport@solem.fr***

## 4- INSTALACIÓN Y CABLEADO MÓDULO

El producto BL debe ser instalado en interiores y colocado en la pared utilizando tres tornillos

- El producto debe ser instalado lo más cerca posible de la toma de corriente. La toma de corriente es un dispositivo de seguridad en caso de problema, el cual debe ser fácilmente accesible en todo momento.

- Asegurarse de que la toma de corriente sobre la que está enchufado el transformador de alimentación tiene una protección contra las sobrecargas y corto-circuitos del tipo disyuntor de 16A (20A para USA)

Utilizar únicamente la fuente de alimentación incluido con el producto 24Vac 0.75A

Temperatura ambiente máxima de funcionamiento del producto : 45°C

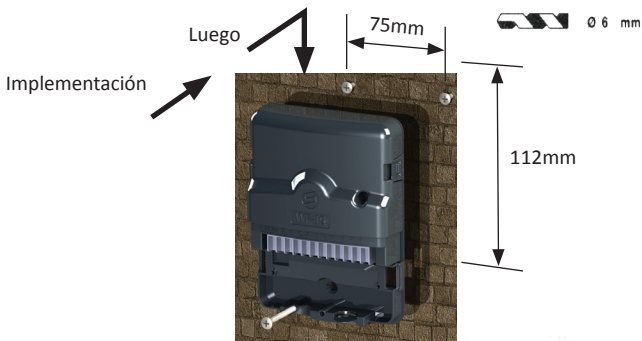

Utiliza válvulas con solenoides 24Vac

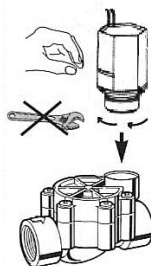
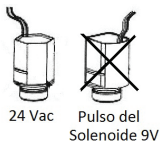

## CABLEADO DE LOS HILOS DEL SOLENOIDE

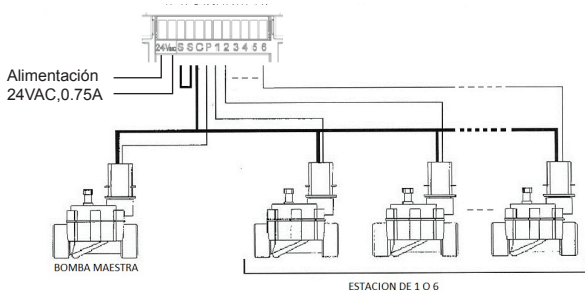

### OPCIÓN: CABLEADO A Sonda DE LLUVIA

Retirar la correa amarilla y poner la sonda de tipo "contacto seco" RSD-BEx o similar en su puesto

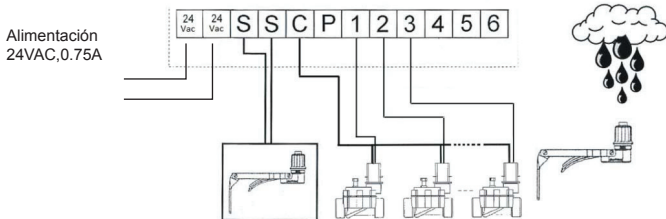

## 5- INFORMACION COMPLEMENTARIA

### Configuración requerida

iOS 7 Minimum: iPhone 4S y superior, iPad 3 y superior, iPod Touch 5.

Android 4.3 Minimum: Samsung S3 y superior / Note 2 / Google Nexus 7 2013 / Sony Xperia Z, Z1

Cualquier aparato con un nivel de Bluetooth Smart 4.0

### Resolucion de las problemas

No hay comunicación o ninguno modulo detectado

Verificar que el Bluetooth del teléfono está activado y verificar que la búsqueda para detectar los productos BL esta activada también..

Ninguna comunicación

1 / Verificar la alimentación  
2 / Verificar la entrada de la sonda  
3 / Verificar los cables de las vías y cortos circuitos

Intervalo en los programas

EL módulo ha perdido la hora durante un corto circuito, debe sincronizar de nuevo con la aplicaciónapplication

### Significado de la LED

LED Status	Significado del led
Rojo fijo durante 5 minutos	Modo instalación : el modulo está en espera de una configuración inicial
2x flash rojo	Se ha producido un corto circuito y el modulo ha perdido la hora
4x flash rojo	Defecto en una vía = corto circuito
Verde fijo	Mode encendido
Flash verde	Riego corriente
Alterna rojo/verde	Una estación está en proceso pero el riego está suspendido por una sonda de lluvia o un "OFF"
Apagada	Ninguna alimentación



## **6- DECLARACIÓN DE CONFORMIDAD A LAS DIRECTIVAS EUROPEAS**

Solem Electronique declara que el tipo de Módulo Sector Riego BL-IS cumple con los requisitos esenciales de la directiva R & TTE 1999/5/CE.

Este producto cumple con los siguientes estándares :

Norma RADIO estándar ETSI EN 300 328 v1.8.1

Norma CEM: EN 62311 (2008) y la Recomendación 1999/519/CE

Norma ETSI EN 301 489-1 v.1.9.2 EMC y ETSI EN 301 489-17 v2.2.1

Norma de Seguridad Eléctrica: EN 60950-1 ed. 2006 + A1 ed. A11 2010 + 2009 + A12 2011 y IEC 60950-1 ed. 2

CLAPIERS en 22/10/13

Director General SOLEM ELECTRONIQUE

ZAE La Plaine

5, rue Georges Besse

34830 Clapiers

FRANCE

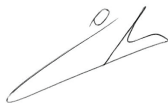
A handwritten signature in black ink, consisting of a stylized, cursive script that appears to be the name 'Solem'.

# BL-IS – Programmatore Per Irrigazione

## GUIDA ALL'INSTALLAZIONE



FR	P01
EN	P11
ES	P22
IT	<b>P33</b>



[customersupport@solem.fr](mailto:customersupport@solem.fr)

+33 467 592 425

[www.solem.fr](http://www.solem.fr)

## INTRODUZIONE

I programmatori BL comunicano con smartphone o tablet tramite l'applicazione SolemWF utilizzando la tecnologia Bluetooth 4.0 (Low Energy)... disponibile sui più recenti dispositivi in commercio (iPhone 4s o versioni successive, Samsung S3 o versioni successive ecc...).

Assicuratevi che il vostro dispositivo possa essere accoppiato tramite il sistema Bluetooth 4.0.

I programmatori della serie BL permettono di gestire l'irrigazione, l'illuminazione e altre utenze elettriche quali, per esempio, fontane, pompe o qualsiasi dispositivo elettrico che può essere avviato con un relè a contatto secco

Come prima operazione è necessario associare il programmatore BL con il proprio smartphone o tablet

# 1- SCARICARE L'APPLICAZIONE SolemWF

Assicurarsi che il dispositivo smartphone o tablet sia connesso ad internet (Wi-Fi o 3G)

effettuare il download dell'applicazione SolemWF



da App Store o Google Play (Play Store).



## 2- ASSOCIAZIONE

1 - Una volta alimentato, il programmatore BL-IS si avvia in modalità “associazione” per 2 minuti

2 - Attivare il Bluetooth sul proprio smartphone o tablet

3 - Avviare l'applicazione SolemWF



Al primo avvio dell'applicazione appariranno le seguenti schermate

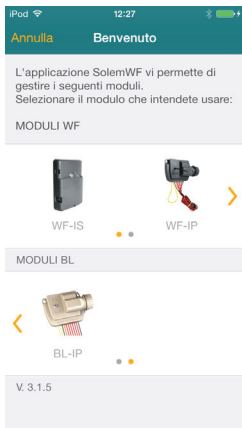
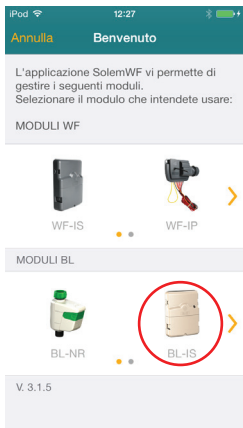

4 - Far scorrere le immagini dei moduli BL per visualizzare tutti i modelli e Cliccare sull'immagine che corrisponde al modulo BL che volete associare

Il programmatore apparirà con il carattere arancione tra la lista di quelli rilevati dall' applicazione.

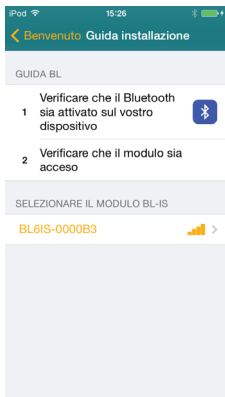

5 - Premere sul nome del modulo. Tale nome corrisponde al “Numero di Identificazione” leggibile sull’etichetta posta sul retro del prodotto.

***Importante :***

*Potrete facilmente cambiare il nome del modulo o aggiungere un Codice di sicurezza allo scopo di evitare che chiunque possa connettersi con il vostro programmatore Bluetooth e cambiare i vostri dati.*



6 - Per cambiare il nome del programmatore, cliccare sull' icona



modificare il nome e premere "Cambiare".

7 – In caso desideriate cambiare il Codice di sicurezza, premere «Codice di sicurezza»



Inserire un codice fino a 7 caratteri: premere quindi "Cambiare"

8 - Premere "Associare"  
Il vostro prodotto appare quindi nella lista dei moduli associati

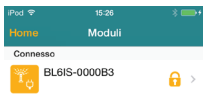

*Se avete inserito un Codice di sicurezza, apparirà un lucchetto sulla schermata della lista moduli*

## **INOTA IMPORTANTE**

*Per aggiungere altri moduli o associare nuovamente un prodotto, dovrete andare alla schermata principale e premere « Aggiungere un modulo ».*

*Riprendere dalle istruzioni di associazione punto N°1, controllate quindi che il Numero di Identificazione sull'etichetta posta sul retro del prodotto corrisponda a quella del modulo rilevato prima di cliccare per associarlo.*

## **IN CASO DI SMARRIMENTO DEL CODICE DI SICUREZZA**

Se smarrite o scordate il codice di sicurezza, dovrete scollegare l'alimentazione elettrica e ricollegarla dopo alcuni secondi ponendo quindi il programmatore in modalità RESET.

Premere quindi « Aggiungere un modulo » sulla schermata principale e seguite le istruzioni per assegnare il nuovo codice di sicurezza

## **3- PROGRAMMAZIONE**

La programmazione è semplice ed intuitiva. Creare un programma, una pianificazione ed ogni altra attività risulta estremamente intuitivo. Per ogni esigenza contattare il servizio tecnico presso :

**progetti@dti.it**



## 4- MONTAGGIO E CABLAGGIO DEL PROGRAMMATORE

Il BL non può essere installato all'aperto. Può essere fissato al muro tramite le due viti incluse.

- Installare il BL più vicino possibile alla presa elettrica. La presa deve essere facilmente raggiungibile per sconnettere l'apparecchio nel caso si debba farlo.
- Assicurarsi che la presa elettrica alla quale il trasformatore sarà connesso sia protetta da un interruttore di sicurezza a 16A (20A per gli Stati Uniti).

Utilizzare l'alimentatore in dotazione con il prodotto 24Vac 0.75A

Massima temperatura ambientale di funzionamento del prodotto : 45°C

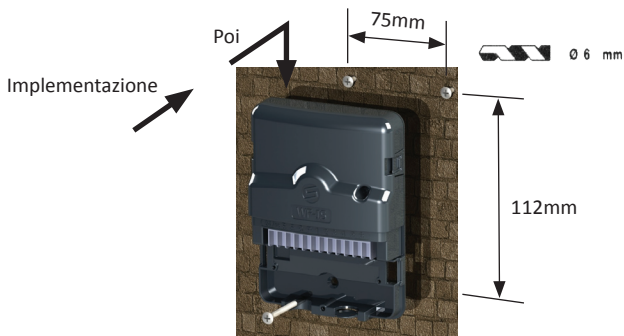

Utilizzare valvole con solenoidi 24Vac

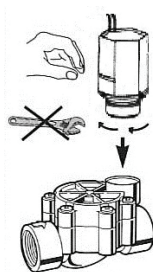
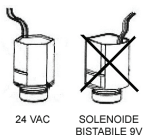

## CABLAGGIO ELETTRICI CON I SOLENOIDI

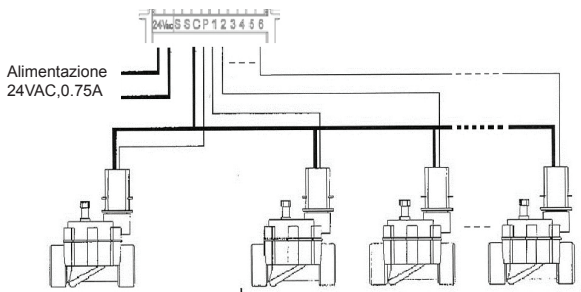

### OPTION : CABLAGGIO DEL SENSORE PIOGGIA

Rimuovere il cavo giallo esistente nei morsetti S S e collegare i fili del sensore pioggia (contatto secco N.C. tipo RSD-BEx o equivalente)

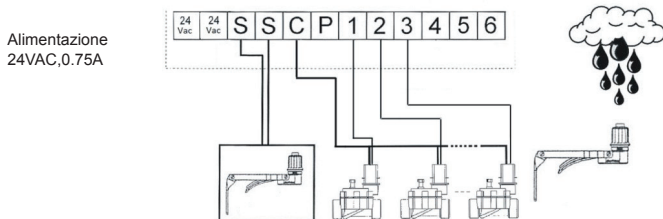

## 5- INFORMAZIONI AGGIUNTIVE

### Apparecchi compatibili :

iOS 7 o successivi : iPhone 4S e versioni successive, iPad 3 e versioni successive, iPod Touch 5.

Android 4.3 o successivi : Samsung S3 e versioni successive / Note 2 / Google Nexus 7 2013 / Sony Xperia Z, Z1

Tutti i dispositivi dotati di Bluetooth Smart 4.0.

### Soluzione problemi

Nessuna comunicazione o nessun modulo trovato

Controllate che la comunicazione Bluetooth del dispositivo sia attivata e sull'applicazione sia attiva la ricerca dei moduli BL dal menu impostazioni

Non irriga

1/ Verificare alimentazione  
2/ Verificare il sensore  
3/ Verificare i cavi delle stazioni e l'eventuale presenza di interruzioni e/o corto circuiti

Programmazione saltata

Il modulo ha perso l'orario perché non alimentato per un lungo periodo. Sincronizzare nuovamente ora e data con il dispositivo smartphone/tablet

### Significato del LED nella parte frontale del modulo

Stato del Led	Significato
Rosso fisso 2 min	Modalità installazione: l'unità sta attendendo di essere configurata
2 x rosso lampeggiante	Perdita orario
4 x rosso lampeggiante	Cortocircuito
Verde fisso Verde lampeggiante	Modalità normale a riposo In attività
Alternativamente rosso/verde	1 Stazione in corso ma l'irrigazione è sospesa da un sensore di pioggia o OFF
Spento	Assenza di alimentazione

## 6 - DICHIARAZIONE DI CONFORMITA'

Solem Electronics dichiara che il modulo BL-IS è conforme ai requisiti espressi nella direttiva R & TTE 1999/5/EC.

Questo prodotto utilizza e/o opera nei seguenti standard:

Radio : ETSI EN 300 328 v.1.8.1

EMF : EN 62311 (2008) e raccomandazione 199/519/CE

CEM : ETSI EN 301 489-1 v.1.9.2 e ETSI EN 301 489-17 v.2.2.1

Sicurezza Elettrica : EN 60950 (2006) + A1 (2010) + A11 (2009) + A12 (2011) e IEC 60950-1 ed. 2

Clapiers, 10/22/13

Solem Electronique ZAE la Plaine  
5, rue Georges Besse  
34830 Clapiers  
France

A handwritten signature in black ink, consisting of a stylized, cursive script that appears to be the name 'Solem'.